

higher power, wide terminal type flat chip resistors (anti sulfuration)



features

- Anti-sulfuration type, wide-side termination (reverse-geometry) type flat chip resistor
- Excellent anti-sulfuration characteristic due to using high sulfuration-proof inner top electrode material
- Suitable for both flow and reflow solderings
- Products meet EU RoHS requirements. EU RoHS regulation is not intended for Pb-glass contained in electrode, resistor element and glass.
- AEC-Q200 Tested

dimensions and construction

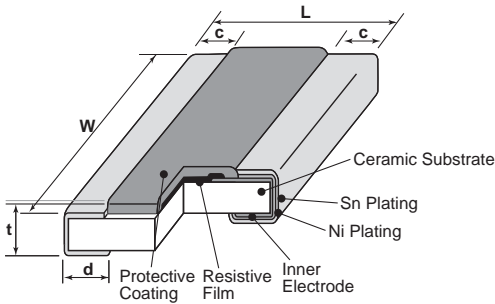

Type (Inch Size Code)	Dimensions inches (mm)				
	L	W	c	d	t
2B15 (0612)	$.063 \pm .008$ ($1.6 \pm .02$)	$.126 \pm .012$ ($3.2 \pm .03$)	$.012 \pm .008$ (0.3 ± 0.2)	$.018 \pm .006$ (0.45 ± 0.15)	$.024 \pm .004$ (0.6 ± 0.1)
2H2 (1020)	$.098 \pm .008$ ($2.5 \pm .02$)	$.197 \pm .008$ ($5.0 \pm .02$)	$.016 \pm .008$ (0.4 ± 0.2)	$.030 \pm .006$ (0.75 ± 0.15)	$.024 \pm .004$ (0.6 ± 0.1)
3A3 (1225)	$.122 \pm .004$ ($3.1 \pm .01$)	$.248 \pm .006$ (6.3 ± 0.15)	$.018 \pm .008$ (0.45 ± 0.2)	$.030 \pm .006$ (0.75 ± 0.15)	$.024 \pm .004$ (0.6 ± 0.1)

ordering information

WK73R	2B15	R	T	TD	10R0	F
Type	Size	Characteristic	Termination Material	Packaging	Nominal Resistance	Resistance Tolerance
WK73S WK73R	2B15: 1.5W ¹ 2H2: 2W ¹ 3A3: 3W ¹	R: Anti-Sulfur	T: Sn	TD: 0612: 7" 4mm pitch punched paper TE: 1020, 1225: 7" 4mm pitch embossed plastic For further information on packaging, please refer to Appendix A	±1%: 3 significant figures + 1 multiplier "R" indicates decimal on value <100Ω ±5%: 2 significant figures + 1 multiplier "R" indicates decimal on values <10Ω	F: ±1% J: ±5%

Contact us when you have control request for environmental hazardous material other than the substance specified by EU RoHS.

applications and ratings

Part Designation	Power Rating	Rated Ambient Temp.	Rated Terminal Part Temp.	T.C.R. (X 10 ⁻⁶ /K)	Resistance Range (Ω)		Maximum Working Voltage	Maximum Overload Voltage	Operating Temperature Range
					F±1% E-24 • E-96	J±5% E-24			
WK73S2B15RT (0612)	1.5W ¹	70°C	95°C	±100	1 ~ 9.76	1 ~ 9.1	200V	400V	-55°C to +155°C
					±150	0.3 ~ 0.976			
WK73R2B15RT (0612)	1.5W ¹	70°C	95°C	±100	10 ~ 9.76k	10 ~ 9.1k	200V	400V	
WK73S2H2RT (1020)	2.0W ¹	70°C	95°C	±100	1 ~ 9.76	1 ~ 9.1			
					±150	0.2 ~ 0.976	0.2 ~ 0.91		
WK73R2H2RT (1020)	2.0W ¹	70°C	95°C	±100	10 ~ 430k	10 ~ 430k	200V	400V	
WK73S3A3RT (1225)	3.0W ¹	70°C	95°C	±100	1 ~ 9.76	1 ~ 9.1			200V
					±200	432k - 1M	470k - 1M		
WK73R3A3RT (1225)	3.0W ¹	70°C	95°C	±100	10 ~ 330k	10 ~ 330k	200V	400V	
				±200	332k - 1M	360k - 1M			

If any questions arise whether to use the "Rated Ambient Temperature" or the "Rated Terminal Part Temperature" in your usage conditions, please give priority to the "Rated Terminal Part Temperature".

Rated voltage = $\sqrt{\text{Power rating} \times \text{resistance value}}$ or max. working voltage, whichever is lower

*1 If you use at the rated power, please keep the condition that the terminal of the resistor is below the rated terminal part temperature.

Please refer to the derating curves based on the terminal temperature of right side on the next page.

For more details, please refer to "Introduction of the derating curves based on the terminal part temperature" on the beginning of our catalog.

Derating Curve

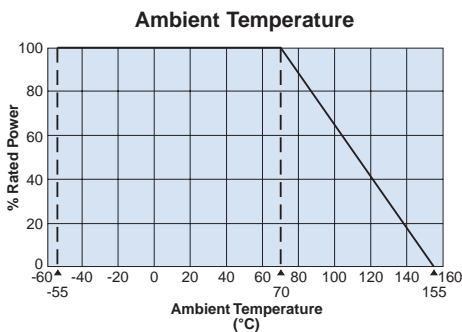

For resistors operated at an ambient temperature of 70°C or above, a power rating shall be derated in accordance with the above derating curve.

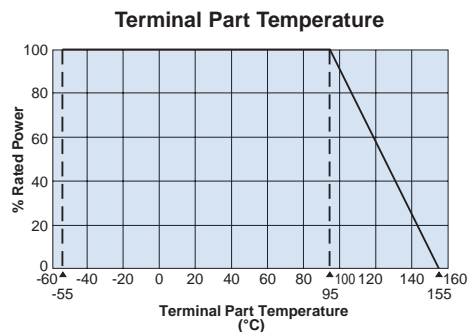

For resistors operated terminal temperature of described for each size or above, a power rating shall be derated in accordance with the derating curve. Please refer to "Introduction of the derating curve based on the terminal part temperature" in the beginning of our catalog before use.

If you want to use at rated power¹, use derating curves based on the terminal part temperature above.

higher power, wide terminal type flat chip resistors (anti sulfuration)

Temperature Rise

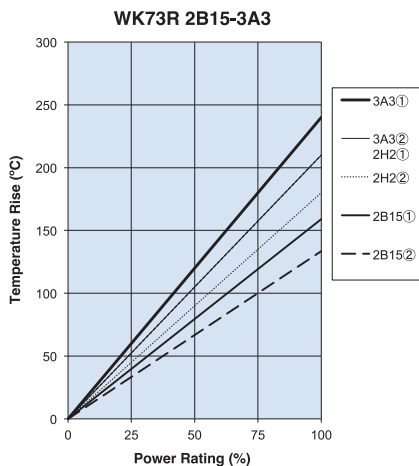
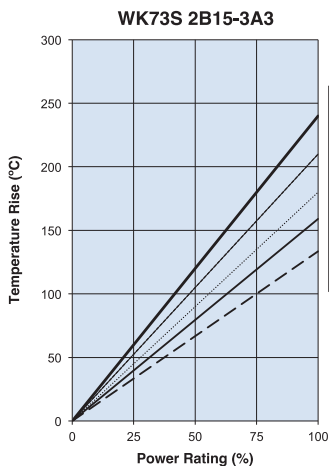

Regarding the temperature rise, the value of the temperature varies per conditions and board for use since the temperature is measured under our measuring conditions.

Measurement condition
Room temperature: 25°C
PCB: FR-4t = 1.6mm
Cu foil thickness: 35µm

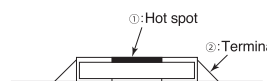

One-Pulse Limiting Electric Power

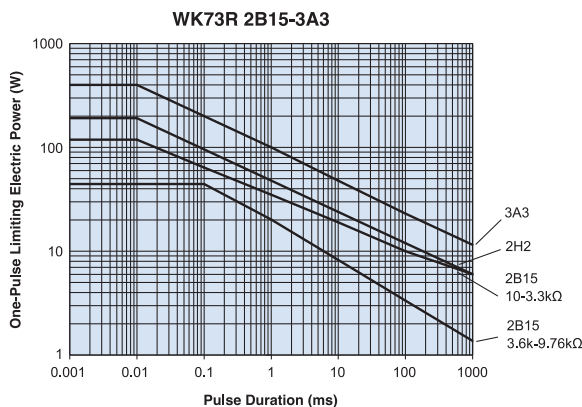
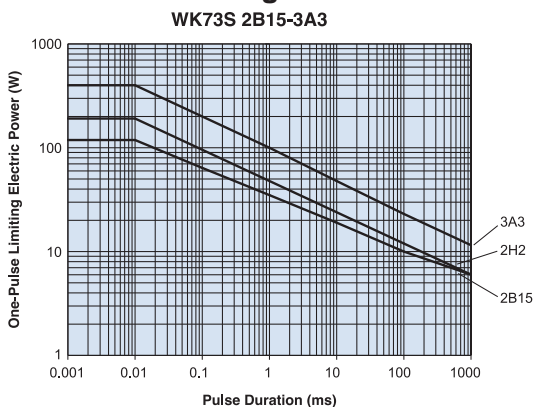

The maximum applicable voltage is equal to the max. overload voltage.
Please ask us about the resistance characteristic of continuous applied pulse.
The pulse endurance values are not assured values, so be sure to check the products on actual equipment when you use them.

environmental applications

Performance Characteristics

Parameter	Requirement $\Delta R \pm(\%+0.005\Omega)$		Test Method
	Limit	Typical	
Resistance	Within specified tolerance	—	25°C
T.C.R.	Within specified T.C.R.	—	+25°C/-55°C and +25°C/+125°C
Overload (Short time)	±2%	±0.2%	Rated voltage x 2.0 for 5 seconds
Resistance to Solder Heat	±1%	±0.2%	260°C ± 5°C, 10 seconds ± 1 second
Bending Test	±1%	±0.1%	Holding point 90mm, Bending 1 time, Bending 5mm
Rapid Change of Temperature	±2%	±1%	-55°C (30 minutes) / +125°C (30 minutes), 1000 cycles
Moisture Resistance	±2%	±0.2%	40°C ± 2°C, 90%-95% RH, 1000 hours, 1.5 hr ON, 0.5 hr OFF cycle
Endurance at 70°C	±2%	±0.2%	70°C ± 2°C, 1000 hours, 1.5 hr ON, 0.5 hr OFF cycle
High Temperature Exposure	±1%	±0.2%	+155°C, 1000 hours
Sulfuration Test	±5%	±0.2%	Soaked in industrial oil with 3.5% sulfur concentration 105°C ± 3°C, 500 hours

Please refer to conventional products for characteristic data such as temperature rise.

Additional environmental applications can also be found at www.koaspeer.com

Specifications given herein may be changed at any time without prior notice. Please confirm technical specifications before you order and/or use.

3/5/25